



## Pat Sloan Layout for Aurifil's 2019 Designer of the Month Blocks

Hi I'm Designer, Author, **Pat Sloan**. Thank you for joining me this year for my Mystery Quilt hosted by **Aurifil.com**!

**[www.Aurifil.com](http://www.Aurifil.com)**  
**[www.PatSloan.com](http://www.PatSloan.com)**

I hope you enjoy making this quilt. These instructions may not be reproduced by any mechanical or electronic means, including photocopying. Making copies for any purpose other than your own personal use is a violation of copyright laws. ©2020 Pat Sloan & Co. LLC, All rights reserved.

*Pat Sloan* the voice of quilting™  
[www.patsloan.com](http://www.patsloan.com)

(1)

# Pat Sloan Layout for Aurifil's 2019 Designer of the Month Blocks

## Setting Supply List

2 1/8 yds White Background Fabric  
1/4 yd Half Square Triangle fabric (HST)

2/3 yd Star Point Fabric

1/2 yd Star Center Fabric  
1/4 yd Center Sashing & Corner Stones

---

## Cutting Directions

### White Background Fabric

- Cut 2 outer borders 1.5" x 60.5"
- Cut 2 outer borders 1.5" x 62.5"
  
- Cut 4 inner border 2.5" x 32.5"
  
- Cut 16 squares 4" x 4" for HST
- Cut 32 squares 4" x 4" for star points
  
- Cut 4 rectangles 2.5" x 3.5"
- Cut 36 squares 3.5" x 3.5"
  
- Cut 1 square 2.5" x 2.5"  
for middle

### Half Square Triangle Fabric

- Cut 16 squares 4" x 4"

### Star Point Fabric

- Cut 32 squares 4" x 4"

### Star Center Fabric

- Cut 8 squares 6.5" x 6.5"

### Center sashing & corner stones

- Cut 4 strips 2.5" x 12.5"
- Cut 4 squares 2.5" x 2.5"

# Pat Sloan Layout for Aurifil's 2019 Designer of the Month Blocks Star Blocks

## Directions

1) Use the 4" star point fabric and 4" background fabric to make the Star points.  
Follow the Half Square Triangle directions on the last page  
Trim to 3.5" x 3.5"  
Make 64 units

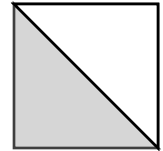

2) Following the diagram, Assemble the Star points units  
Measures 3.5" x 6.5"  
Make 32 units

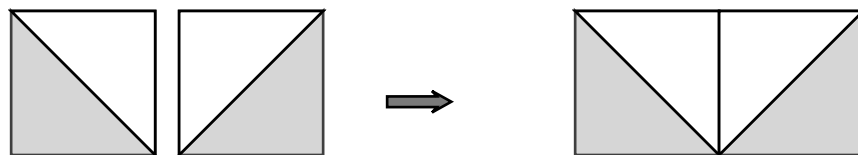

3) Following the diagram, sew the top and bottom rows using the 3.5" background squares  
Measures 3.5" x 12.5"  
Make 16

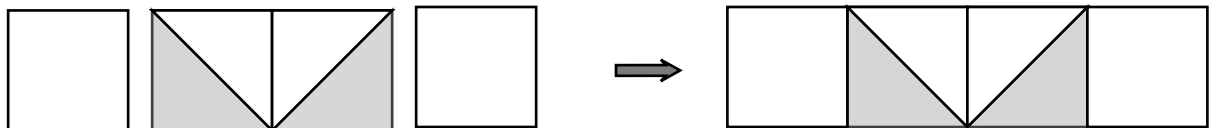

4) Following the diagram, Assemble the block by sewing the units together  
Measures 12.5" x 12.5"  
Make 8

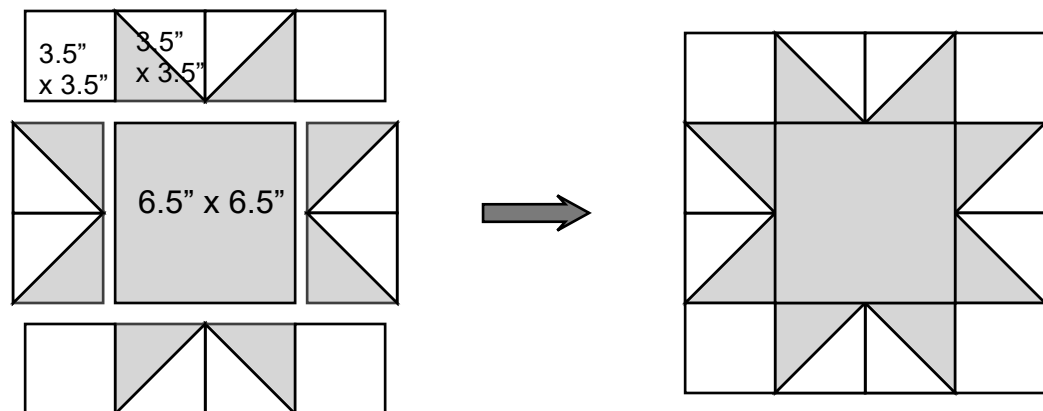

# Pat Sloan Layout for Aurifil's 2019 Designer of the Month Blocks

## HST Directions

- 1) Use the 4" HST fabric and 4" background fabric to make the HST units. Follow the Half Square Triangle directions on the last page  
Trim to 3.5" x 3.5"  
Make 32 units

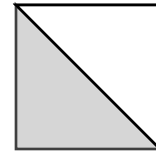

## Assemble the Center

- 1) Following the diagram and noting direction of the HST sew 4 HST to the top of a block  
Sew 4 more HST together and sew a 3.5" background to the end  
Sew to the block  
Make 4 following diagram placement  
Measures 15.5" x 15.5"

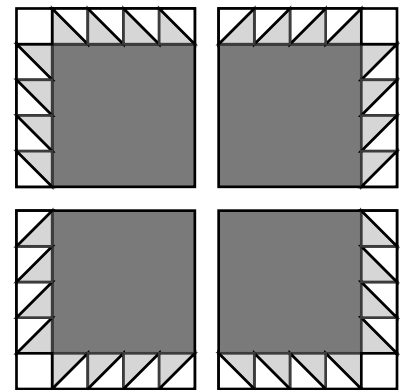
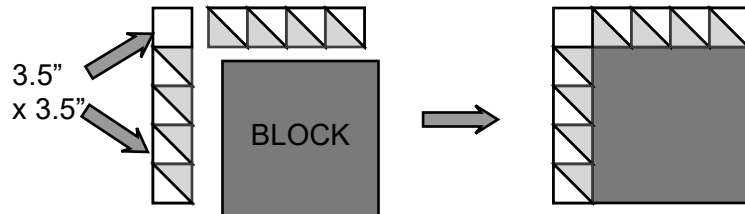

- 2) Following the diagram assemble the middle unit using the 4 units from above, the 2.5" x 3.5" Rectangles, 2.5" x 12.5" sashing, the 32.5" strips, and the 2.5" squares  
Make 1 unit  
Measures 36.5" x 36.5"

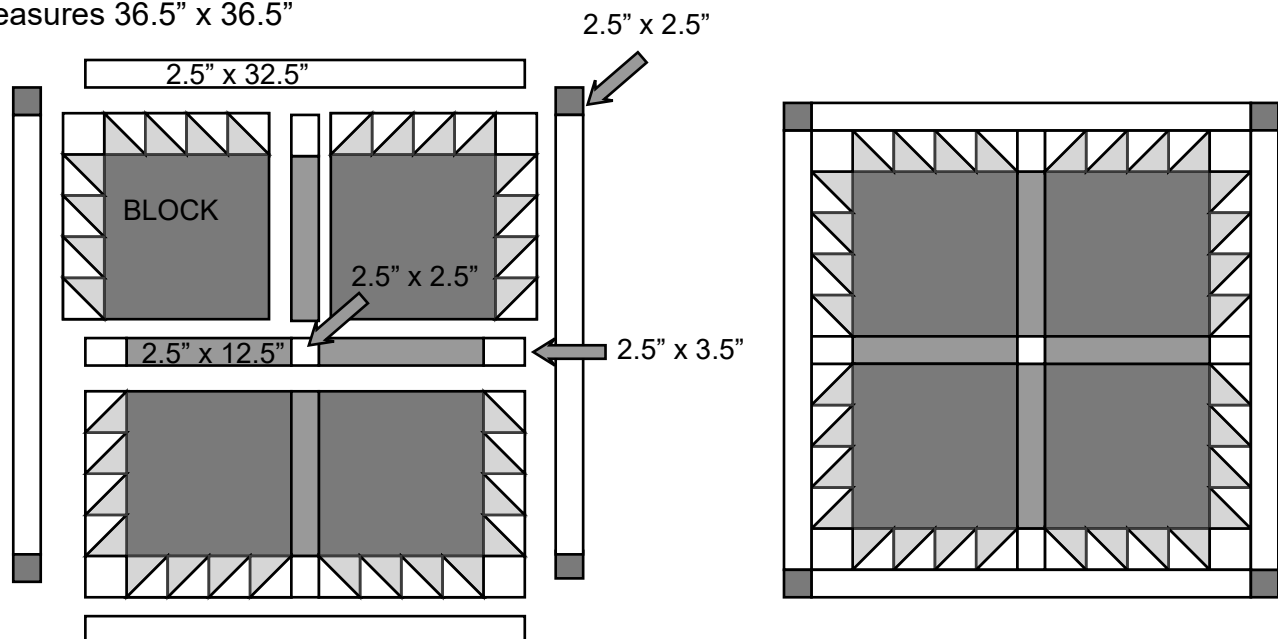

- 3) Following the diagram on the next page to alternate Blocks and Stars.  
Sew the 60.5" and 62.5" borders on at the end  
Make 1 unit Measures 62.5" x 62.5"

# Pat Sloan Layout for Aurifil's 2019 Designer of the Month Blocks

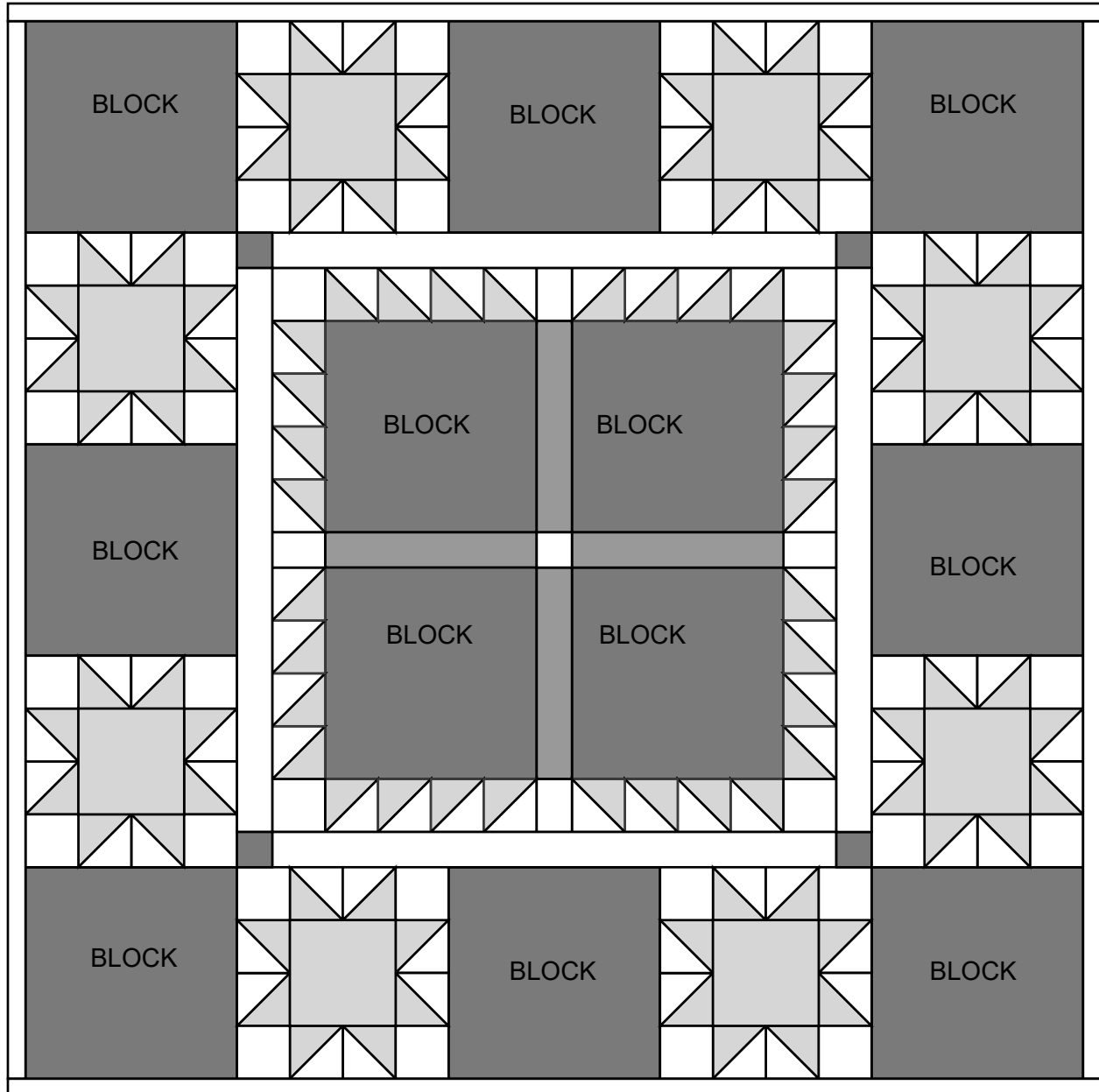

Quilt 62.5" x 62.5"

Website [PatSloan.com](http://PatSloan.com) - Articles & Tutorials [blog.PatSloan.com](http://blog.PatSloan.com)  
Facebook Classroom - [Facebook.com/PatSloanQuiltFun](https://www.facebook.com/PatSloanQuiltFun)

I hope you enjoy making this quilt. These instructions may not be reproduced by any mechanical or electronic means, including photocopying. Making copies for any purpose other than your own personal use is a violation of copyright laws. ©2020 Pat Sloan & Co. LLC, All rights reserved.

*Pat Sloan* the voice of quilting™  
[www.patsloan.com](http://www.patsloan.com) (5)



## Half Square Triangles Tutorial

**NOTE- For other ways to make HST units, see my book  
"Pat Sloan's Teach Me to Sew Triangles"**

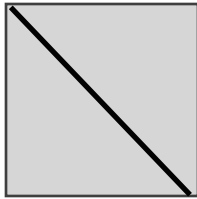

**Step 1**

- Draw a line on the back of all the lighter squares

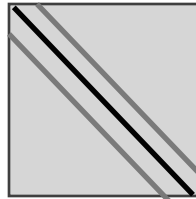

**Step 2**

- Layer the 2 squares  
- Sew a  $\frac{1}{4}$ " seam on both Sides of the drawn line

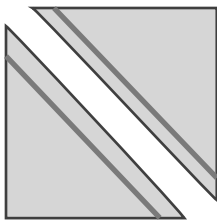

**Step 3**

Cut on the drawn Line for 2 HST

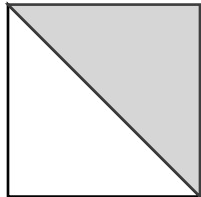

**Step 4**

-Trim squares to size in directions using a square ruler with a diagonal line placed on the Seam.



**See my Book  
"Pat Sloan's Teach Me to Sew Triangles"  
For Step by Step photos and methods to  
make more at one time**